

HD 32-A MK4

ACTIVE TWO-WAY SPEAKER



DESCRIPTION

The RCF HD 32-A MK4 two way active speaker is capable of 131 dB max SPL with clear and definite sound. At the core of HD 32-A design is the new ND840 compression driver. The 3.0"; voice coil designs allow a crossover point as low as 700 Hz and therefore almost all of the vocal range can be produced by the driver. This allows even better coverage, dispersion control and superior efficiency. The new D-Line MK4 speakers boosts the performance with a series of brand new transducers, improves the sound quality with the revolutionary FIRPHASE processing and renew the grille design to exalt the professional look. The concept of the HD-Line derives from the touring industry, bringing in a elegant and compact cabinet all the experience of RCF professional sound with the maximum reliability and strength for the intensive use on the road. Connect your microphone, your device or your mixer to the speaker and turn up the volume: real plug&play. Perfect as a main front of house in small PA systems, high powered floor monitoring and unobtrusive fixed installation.

MAIN APPLICATIONS

- Rental
- Live sound
- Audio visual
- Theatre

MAIN FEATURES

- 1400 watt 2-way peak power
- 131 dB max SPL
- Class-D Bi-amplification, SMPS
- DSP sound processing
- 90° x 60°, wide dispersion constant directivity horn
- 12" woofer, high power, 2.5" voice coil
- 1.4" HF driver, titanium dome, neodymium 3.0" voice coil
- FIRPHASE processing

ACOUSTICAL SPECIFICATIONS

Frequency response:	45 Hz ÷ 20000 Hz
Max SPL:	131 dB
Horizontal coverage angle:	90°
Vertical coverage angle:	60°
Compression driver:	1.4" neo, 3.0" v.c.
Woofer:	12", 2.5" v.c.

INPUT/OUTPUT SECTION

Input signal:	bal/unbal
Input/Output connector:	XLR, Jack
Input sensitivity:	- 2 dBu / + 4 dBu

PROCESSOR SECTION

Crossover frequencies:	700 Hz
Protections:	thermal, rms
Limiter:	soft limiter
Controls:	Boost, Volume, Mic/Line

AMPLIFIER

Total Power:	1400 W PEAK - 700 W RMS
High frequencies:	400 W PEAK - 200 W RMS
Low frequencies:	1000 W PEAK - 500 W RMS
Cooling:	convection
Connection:	Powercon IN/OUT

PHYSICAL

Height:	647 mm (25.47")
Width:	380 mm (14.96")
Depth:	380 mm (14.96")
Weight:	18 Kg (39.68 kg/lbs)
Cabinet:	PP Composite
Hardware:	1 x M10 top, 1 x M10 bottom, 3 x M6 bottom
Handles:	1 top, 2 side
Colour:	Black



HD 32-A MK4

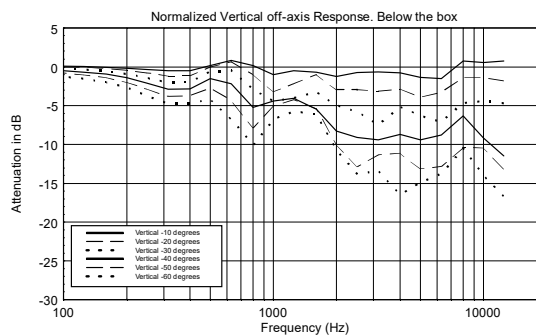
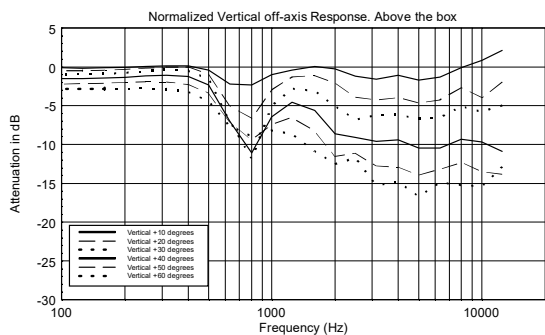
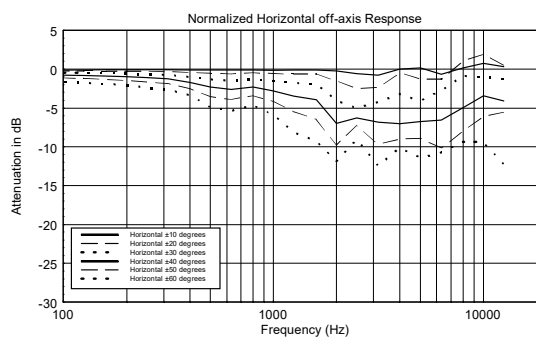
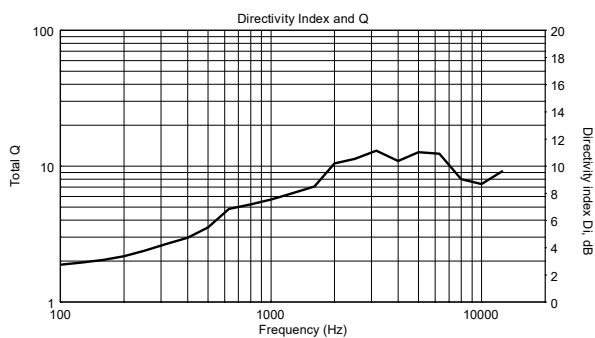
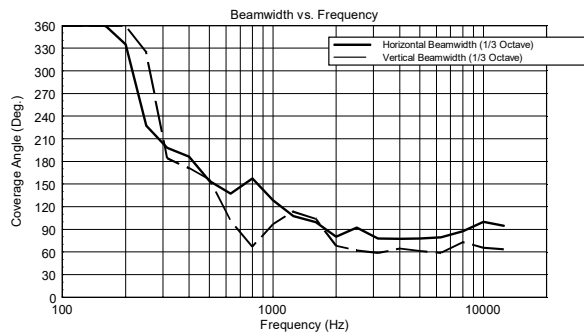
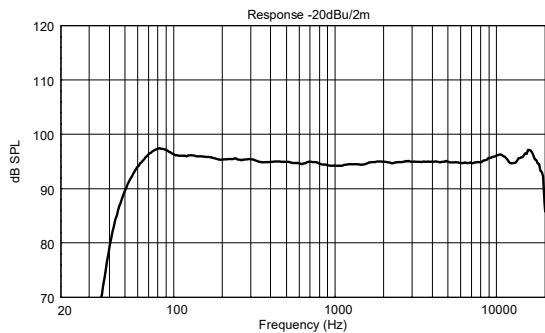

HD 32-A MK4



HD 32-A MK4

Horizontal 1/3 Octave Polars

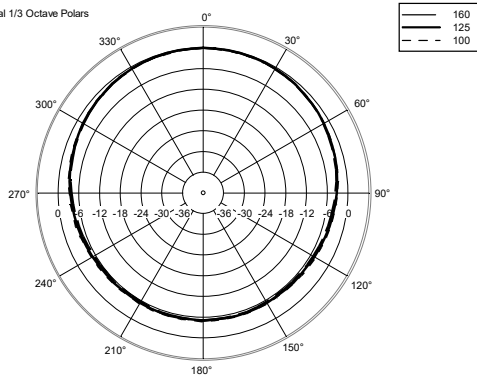

Horizontal 1/3 Octave Polars

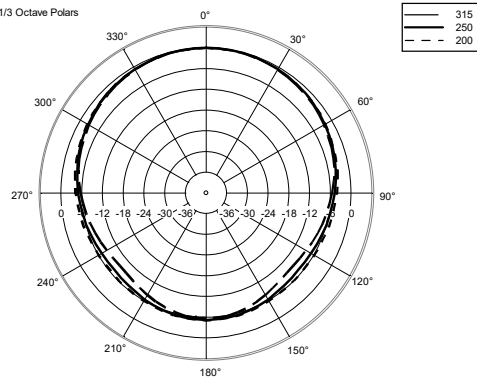

Horizontal 1/3 Octave Polars

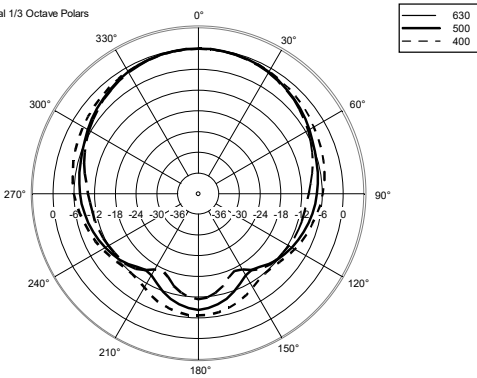

Horizontal 1/3 Octave Polars

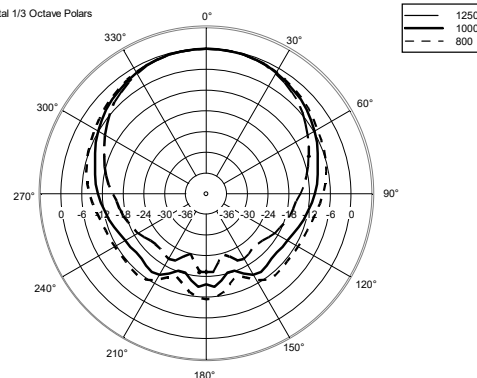

Horizontal 1/3 Octave Polars

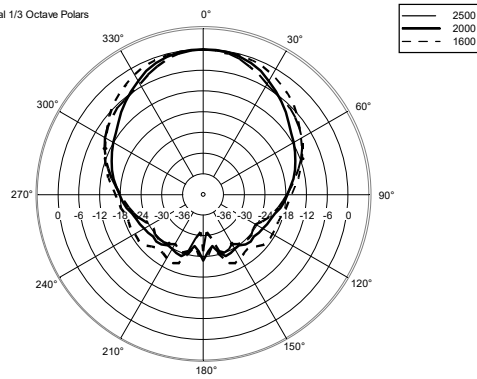

Horizontal 1/3 Octave Polars

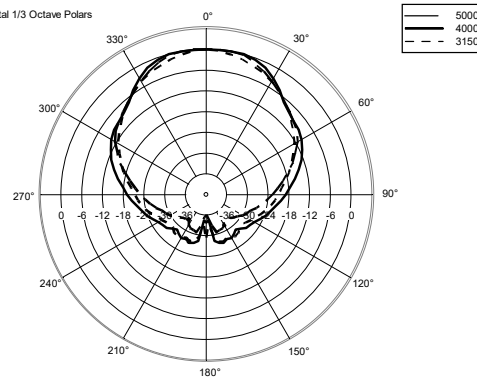

Horizontal 1/3 Octave Polars

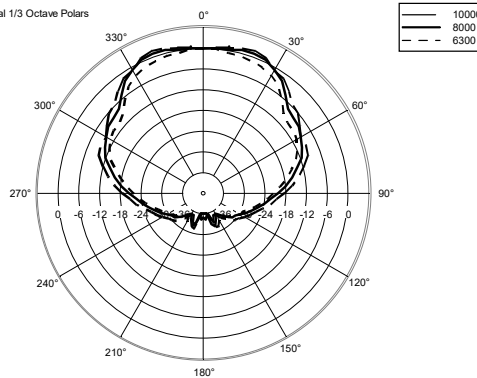

Horizontal One Octave Polars

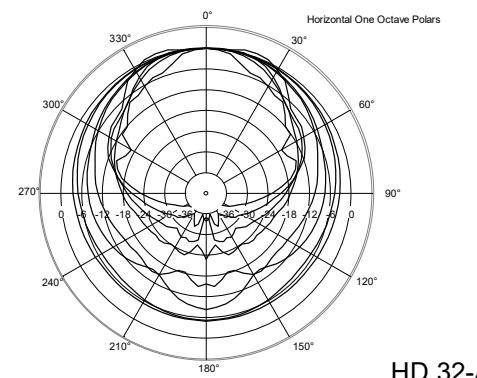

HD 32-A MK4



HD 32-A MK4

PART NUMBER

13000516 (220-240V)
13000517 (115V)

DIMENSIONS (All data are in mm)

